

Technique Max HPL & Aptico

General Processing Guidelines



For you to create



Fundermax

www.fundermax.com





Contents

Quality	4
Material properties	6
Max HPL and the environment	8
Transport and handling	9
Processing recommendations	10
Cleaning	18
Max HPL panel with Aptico surface	20

Note

For the latest version of this brochure please visit www.fundermax.com

The diagrams within this brochure are purely for reference and are not true to scale. This issue replaces and supersedes all previous copies of Fundermax's Interior HPL Aptico Technical Brochures.

Fundermax

No matter whether it's furniture, facades, or interior design: where ideas and materials meet, you'll find Fundermax. As a global market leader in the field of compact panels and a manufacturer of high-quality wood-based materials and laminates, the company is proud to look back on a history spanning 130 years. The continued success is based on the highest quality, innovative and varied design, and sustainable production. Made in Austria—with great love for wood as a natural material, creations, and imagination.

- modern production facilities in Austria and Norway
- around 1,500 employees
- annual sales of €500 million
- part of Constantia Industries AG
- The Austrian Excellence Award (2018)

1 Quality

Max Decorative Laminates – HPL

Max HPL panels are duromer high-pressure laminates in accordance with EN 438-3*, type HGS and are ideal for decorative and high-traffic areas of application (e.g. furniture, interior design, etc.). They are perfect for such applications as they are highly resistant to abrasions, impacts, scratches and heat.

Formats: 2,800 x 1,300 mm, 4,100 x 1,300 mm
Thickness: 1.0 mm

Surface Aptico

Leaves impressions, not fingerprints: The patented technology not only ensures an attractive matte finish, but the anti-fingerprint effect also ensures that it stays beautiful for a long time. In addition to being pleasant to the touch, the Aptico surface is easy to process and particularly durable. But as we know, life leaves its marks. Thankfully, any superficial micro-scratches can be removed through thermal repair.



Advantages

- anti-fingerprint
- low light reflection
- matt structure with a warm feel
- resistant to scratches and abrasion
- easy to process
- easy to clean
- resistant to solvents and common household cleaners

2 Material properties

Characteristics:

- anti-fingerprint (Aptico)
- scratch-resistant
- solvent-resistant
- food-grade
- easy to clean
- hygienic
- suitable for all interior applications
- decorative
- tough
- abrasion proof
- frost and heat resistant
- prolonged temperature resistant HPL -80°C to $+80^{\circ}\text{C}$
- easy to process
- durable
- impact resistant
- resistant to chemicals

Physical properties

Properties	Test method	Assessment	Standard value ¹⁾	Typical value ²⁾	
				Max HPL (HGS/HGP)	Aptico (HDS) ³⁾
Length tolerance	EN 438-2:2016, 6	mm	+10 / -0	+10 / -0	+10 / -0
Thickness tolerance (t = thickness)	EN 438-2: 2016, 5	mm	0,5 ≤ t ≤ 1,0: max +/- 0,10 1,0 < t < 2,0: max +/- 0,15	0,5 ≤ t ≤ 1,0: max +/- 0,10 1,0 < t < 2,0: max +/- 0,15	0,5 ≤ t ≤ 1,0: max +/- 0,10 1,0 < t < 2,0: max +/- 0,15
Raw density	EN ISO 1183-1	g/cm ²	≥ 1,35	≥ 1,47	≥ 1,45

Mechanical properties

Resistance against stress abrasion	EN 438-2:2016, 10	Revolutions	≥ 150 (HGS/HGP) ≥ 350 (HDS)	≥ 185	≥ 480
Impact stress with small diameter ball	EN 438-2:2016, 20	N	≥ 20 (HGS/HGP) ≥ 25 (HDS)	≥ 25	≥ 30
Resistance to cracking under stress	EN 438-2:2016, 23	Rating	4	5	5
Resistance to scratching	EN 438-2:2016, 25	Rating	≥ Grade 3 (HGS/HGP) ≥ Grade 4 (HDS)	≥ 4-5	≥ 5
Formability	EN 438.2:2016, 32	mm	HGP: ≤ 10x Thickness	≤ 10x Thickness -	

Thermal properties

Resistance to water vapour	EN 438-2:2016, 14	Rating		4	4
Resistance to dry heat	EN 438-2:2016, 16	Rating	Gloss: ≥ 3 Other Surfaces: ≥ 4	4	4
Dimensional stability at elevated temperature	EN 438-2:2016, 17	%	length: ≤ 0,55 (HGS/HGP) ≤ 0,45 (HDS) width: ≤ 1,05 (HGS/HGP) ≤ 0,90 (HDS)	length: 0,23 width: 0,60	length: 0,20 width: 0,43
Resistance to moist heat	EN 438-2:2016, 18	Rating	Gloss: ≥ 3 Other Surfaces: ≥ 4	4-5	4-5
Resistance to blistering	EN 438-2:2016, 33	s	HGP: ≥ 15	20	-

Optical properties

Resistance to staining	EN 438-2:2016, 26	Rating	Group 1/2: 5 Group 3: ≥ 4	5	5
Light fastness	EN 438-2:2016, 27	Grey Scale	4-5	4-5	4-5
Gloss level at measuring angle of 85°	EN ISO 2813	GE	- ⁴⁾	- ⁴⁾	7

1) According to EN 438-6

2) Typical values result from internal quality tests. Typical values are only shown as examples and can't be used for any liability on the part of Fundermax (no promised guaranteed values). Fundermax only guarantees compliance with the standard values.

3) Only available in Plain Colours

The surface Aptico corresponds to the specifications of the EN-438 for horizontal use, type HDS. Due to the special surface structure, it can be, however, that the surface especially in combination with dark decors is not suitable for all horizontal uses. If necessary, the corresponding décor must be subjected to a suitable suitability test by the user prior to the potential use.

4) Dependent on the surface structure

**Type HGS (standard quality)****OFI CERT HPL EN 438 HGS**

The key characteristic of this quality are highly durable surfaces which are scratch and impact resistant. Due to their thickness, these surfaces are particularly resistant to boiling water, numerous household chemicals, as well as dry and damp heat. The reverse face of Max HPL panels is designed to ensure flawless adhesion to substrates (for example chipboard, plywood, etc).

Type HGP (postformable quality)**OFI CERT HPL EN 438 HGP**

Type S (HGS), but can be used in pre-determined conditions such as temperature, heating times, etc. (postforming process).

During a cold forming process, cracking may occur with HPL laminate boards, irregardless of the size of the radius.

OFI CERT confirms compliance with EN 438.

Type HDS (Heavy-Duty quality)**HPL EN 438 HDS**

This quality grade differs from HGS and HGP due to its very high: scratch and impact resistance as well as minimal surface abrasion. Because of these properties, the HDS range is perfectly suited to horizontal applications in particularly challenging environments.

3 Max HPL and the environment

Resource and environmentally friendly facade panels

We are specialists in the processing of renewable raw materials – and have been for over 100 years. Our production cycles are closed, production waste is either recycled back into the production process or used to generate energy in our green energy district heating plants. This works so well, that today as a private company we provide district heating to over 8,500 households.

Quality management systems

Fundermax has oriented its production facilities and processes on internationally recognized standards such as ISO 9001, ISO 14001, ISO 50001 and ISO 45001. This fact gives all customers the assurance that they have in their hands a high-quality construction product. And in its procurement of raw materials and intermediate products, Fundermax orients itself on up-to-date standards such as FSC® C101966 and PEFC*.

Sustainable production

Max HPL is made from natural fibre panels – around 65%, by weight – consisting largely of wood that has been processed into “kraft papers”. This wood is a by-product of sawn lumber production or of sawmills. We source these raw materials from vendors certified according to the standards FSC® C101966 or PEFC. These standards ensure that the wood is produced in compliance with internationally applicable rules for sustainable forestry.

The kraft papers are impregnated with synthetic resins in impregnation facilities, dried, and pressed into durable, moisture-resistant panels under high pressure and heat. These panels do not contain organic halogen (or chlorine, fluorine, bromine, etc.) compounds such as are found in greenhouse gases or PVC. They contain neither asbestos nor wood protection agents (fungicides, pesticides, etc.) and are free of sulphur, mercury and cadmium.

The exhaust air removed from the drying process is treated using a process of regenerative thermal oxidation, with the resulting heat being fed back into said drying process. For its installation of this efficient exhaust air treatment, FunderMax was awarded the “Klima:aktiv” award for best practices by the Austrian Energy Agency and the Austrian Federal Ministry of the Environment. This avoids CO₂ emissions of ca. 10,000 tons annually at the production site.

Long lasting & maintenance free

Extensive tests have demonstrated the exceptional durability of Max HPL panels. The manufacturing process ensures a highly resistant surface, producing panels which don't require any maintenance and offer a long service life. The surface doesn't wear easily and, if necessary, can be cleaned with standard cleaning agents. Its durable surface makes it ideal for more demanding applications such as: furniture fronts and various building furnishings.

Waste disposal

Chips and shavings produced by processing (cutting and milling) are not hazardous to human health. This also means that waste can even be disposed of thermally without the emission of environmental toxins such as hydrochloric acid, organic chlorine compounds or dioxins, assuming modern heating systems. At appropriately high temperatures, and assuming both sufficiently long retention of the combustion gas in the combustion space and a sufficient oxygen supply, Max HPL decomposes into carbon dioxide, nitrogen, water and ash. The energy emitted via this process can be put to use. Disposal in properly managed commercial waste disposal sites is unproblematic. As a matter of principle, country-specific laws and regulations with regard to disposal must be adhered to.

4 Max HPL and the environment

Guidelines for handling Max HPL panels

Transport and handling

Handle Max HPL panels with care in order not to damage the edges and surfaces of the high-quality material. In spite of the excellent surface hardness and the installation protection film, the stack weight of Max HPL panels is a possible cause of damage. Therefore, any form of dirt or dust between the panels must definitely be avoided.

Max HPL panels must be secured against slippage during transport. When loading or unloading, the panels must be lifted. Do not push or pull them over the edge (see Fig. 4 01)

Maybe there is a stronger adhesion of the foils on the surface because of the storage. Therefore there might be a higher effort to remove the foil. That does not have any effect to the quality of the product and does not result into a complaint. The transport protection film must not be exposed to heat or direct sunshine.

Storage and air conditioning

Max HPL should always be left in the original packaging. The panels should be stacked horizontally on a flat, stable and padded raised surface. If this is not possible, the panels can be temporarily stored as shown in Fig. 4 03. The panels must lie completely flat. After removing the panels, the original packaging should be closed again.

Cover plates must always be left on the stack (see Fig. 4 02). The top cover should be weighted down. The same applies, in principle, for cut-panel stacks.

Incorrect storage can lead to permanent deformation of the panels.

Max HPL panels should to be stored in closed rooms under normal climatic conditions, temperature about 15°C - 25°C and relative humidity at about 40% - 60%. Climate differences on the two surfaces of a panel are to be avoided.

With pre-installed fastening elements, therefore, care is to be taken that the climatic effect is uniform on all sides. Use intermediate layers of wood or plastic.

Hint for final cleaning

Please ensure that foreign substances (e.g. drilling and machine oils, greases, adhesive residues, etc.) that soil the surface of the Max HPL panels during storage, installation and use are removed immediately without leaving any residue. No responsibility will be accepted for any complaints regarding color, gloss and surface of the panels should these recommendations fail to be observed. For details on how to properly clean Max HPL panels, see page 18.

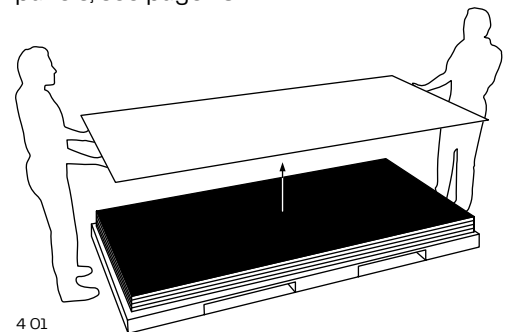

4 01

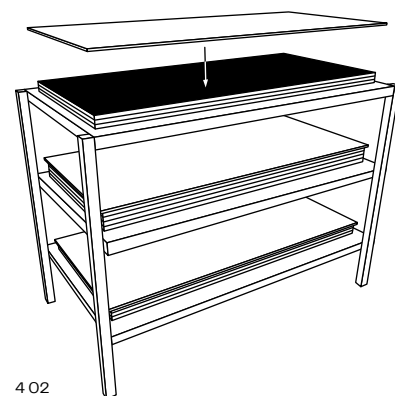

4 02

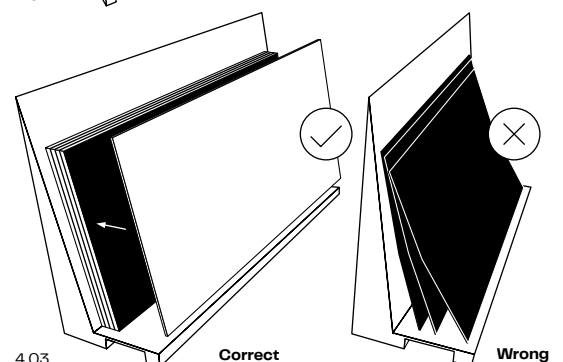

4 03

Correct

Wrong

5 Processing recommendations

Machining of Max HPL Panels and Aptico

General

The surface of Max HPL is made up of high-quality melamine resins and is therefore highly resistant. The processing characteristics of Max HPL panels are similar to those of hardwood. Please refer to the instructions for the optimal processing of Aptico. Carbide cutting tools have proved their worth and are indispensable for cutting Max HPL boards. For a prolonged tool life, diamond tips should also be used.

Sharp blades, smooth technique and well maintained tools are required for flawless results. Breaks, chipping (particularly chipping of the decorative face) are the result of incorrect machining or unsuitable tools. Work surfaces should be smooth and wherever possible joint free, to avoid the build-up of sawdust contamination which could damage the surface of the HPL. This also applies to work tables and the guides of hand-held tools.

The processing of non-glued panels should be carried out on an even, firm surface. Any vibrations or juddering must be avoided, as resulting scores can lead to cracks during stress/expansion (e.g. tension within the panel during temperature or moisture fluctuations); so-called 'tension' or 'notched tears'.



4 01

Safety precautions

This is a list of the recommended personal protective equipment (PPE) which should be used. The normal protective equipment (workwear, safety shoes, hairnet...) required for the respective activity should be worn.



Gloves

Non-bevelled cut edges are naturally sharp posing a risk of injury. It is advisable to use gloves of protection category II with a minimum cut resistance of 2 when handling freshly cut Max HPL panels.

EN 388		Mechanical risks	
		The higher the number, the better the test result	
Test Criteria	Evaluation possibilities		
4 1 2 1	Abrasion resistance	0 - 4	
	Cutting strength	0 - 5	
	Tear strength	0 - 4	
	Puncture resistance	0 - 4	



Safety goggles

As with the manufacturing of any wood materials, tightly-sealed eye protectors must be worn when working with Max HPL.



Dust protection

As with the processing of all wood materials, when working with Max HPL, dust can be created. Please provide adequate respiratory protection (disposable fine dust mask).



Ear protection

As with all wood materials, during the machining of Max HPL, sound levels can rise above 80dB (A). Please always ensure operators have adequate hearing protection.

General processing guidelines

When working with Max HPL panels, the ratio between the number of teeth (z), the cutting speed (vc) and the feed rate (vf) must be observed.

	v_C m/s	f_Z mm
Saw	40,0-60,0	0,02-0,1
Mill	30,0-50,0	0,3-0,5
Drill	0,5-2,0	0,1-0,6

Calculation of cutting speed

$$v_C = D \cdot \pi \cdot n / 60$$

v_C – cutting speed

D – tool diameter [m]

n – tool rotational speed [min⁻¹]

Calculation of feed speed

$$v_f = f_z \cdot n \cdot z / 1000$$

v_f – feed rate [m/min]

f_Z – tooth feed

n – tool rotational speed [min⁻¹]

z – number of teeth

Cutting of Max HPL panels

For straight cuts using a circular saw, a guide bar must be used. It is recommended to use hard metal tipped circular saw blades. Panels should be cut from underneath, in the direction of the teeth, firstly by using a scoring cut followed by the main blade cutting operation:

- WZ/FA For coarse cuts
- FZ/TR For clean cuts on Max HPL panels and panels glued on both sides

When cutting with a circular table saw, a fine-cut saw etc. the following instructions are essential for good results:

- visible side up;
- very narrow saw guide;
- firm alignment of the Max HPL panels on the work bench with the cutting blade;
- correct blade protrusion.

Depending on the blade protrusion, the entry and exit angle, the quality of the cutting edge will change. If the upper cut edge isn't neat, the blade must be adjusted upwards. If the cut edge of the underside is the same, the blade should be adjusted down-wards. The most favourable height setting must be determined.

Max HPL panels can also be cut in a stack. To achieve the best cutting results on both sides, choose a saw with a scoring unit.

Note: Split edges are to be expected when processing with hand held jigsaws!

Circular saw blades

The following tooth forms should be used in the processing of Max HPL or glued Max HPL panels.

WZ/FA (variable tooth with bevel)

An alternative to FZ / TR tooth form

FZ/TR (flat tooth/trapezoid tooth)

Tooth form for processing Max HPL panels.

- WZ / FA for coarse cuts
 - FZ / TR produces a clean cut edge with a prolonged tool life.
- The slightly higher cutting pressure must be observed.

The quality of the cutting edge depends on the set up of the saw, the saw blade and the machining parameters:

Due to the variety of the equipment and tasks, we recommend that you discuss specific requirements with your tool supplier.

For the processing of Aptico, we recommend the same tooth forms – albeit with an increased number of teeth – and always newly refurbished blades in order to achieve an optimum processing quality.

5 02

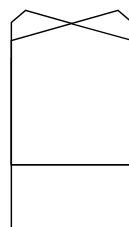

5 03

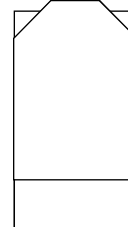

- 5 01 Panel dividing saw
- 5 02 WZ/FA
- 5 03 FZ/TR

Cut edge finishing and profiling

Edge processing by hand

Files are a suitable tool for finishing edges. You should move the file from the outer decor edge to the centre of the panel. For broken edges, fine files, sand paper (100–150 grit) or scrapers can be used successfully. Cut edges should be finished by grinding the surface edge and sanding sharp edges with sandpaper.

Cut edge finishing with hand-held machines/tools

Hand-held overhead routers are used for the flush cutting of Max HPL panel edges. In order to retain the quality of the panel surface, any part which comes into contact with the surface of the handheld router, should be protected with off cuts. Shavings must be carefully removed.

We recommend hard metal-tipped routers, which are also available with indexable inserts. For the best working methods, height-adjustable routers are preferable.

Sharp edges have to be broken afterwards. The overhang of panels at gluing should not be larger than necessary (≤ 5 mm) to avoid too much pressure to the machine at trimming.

Edge processing with stationary equipment

When milling glued Max HPL panels, the optimum ratio between the number of teeth, cutting speed and feed rate should be considered. If the shavings are too small, the machine will scrape (burn) and therefore blunt quickly, thus shortening its lifespan.

If, on the other hand, the shavings are too large, the edge becomes wavy (billowing) and untidy. High rotational speeds are not the only criterion for good edge quality!

For optimum edge quality of Aptico, always use tools with new or refurbished cutting blades.

Due to the high quality and special surface finish of Aptico, tools are likely to wear sooner, than when working with Max HPL panels.

Drilling

For drilling, solid carbide spiral or dowel drills should be used. The exit speed of the drill must be selected in such a way that the melamine surface of the Max HPL panel is not damaged. Shortly before the full-diameter of the drill protrudes through the workpiece, the feed rate should be reduced by approx 50%.

When drilling holes, care must be taken to ensure that sufficient counterpressure is applied. This can be done by using a hardwood or equivalent base or bed and this will prevent the melamine surface from breaking off.

Drills for plastics are best suited for Max HPL panels. These are spiral drills with a tip angle of $\leq 90^\circ$, a large gradient slope and flute. The sharp bits make them ideal for producing "drill holes", as they cut cleanly through to the underside of the material.

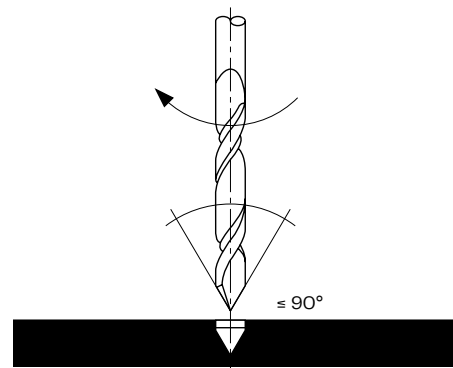

Tension-free

Screws must have enough clearance on all sides so that the material can adapt to temperature and humidity fluctuations. This will prevent the formation of cracks around the drill holes.

For HPL composite elements, countersunk head screws are not permitted. If countersunk screws are used, support rosettes (Fig. 4 07) are required.

Screws must always cover the drill hole (Fig. 4 08).

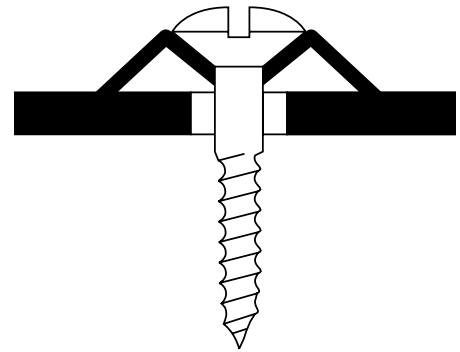

5 05

Milling

Inner recesses and cut-outs

For internal recesses and cut-outs, the corners must always be rounded off. The inner radius should be kept as large as possible (minimum radius 5 mm). For internal recesses and milling over 250 mm side length, the radius must be increased gradually according to the side length.

Internal recesses can be formed directly with the milling tool, or predrilled with a corresponding radius, before the recess is milled by moving from drill hole to drill hole. Sharp corners must be avoided as they can lead to cracks occurring due to tension in the panel. Furthermore, all edges must be free from notches. If, for design reasons, a sharp-edged inner corner is required, this will have to be formed by assembling fabricated and cut panels.

Tools suitable for the cutting, milling and drilling of inner recesses and cut-outs are described in the previous sections.

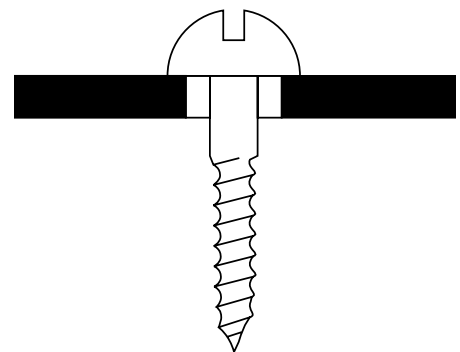

5 06

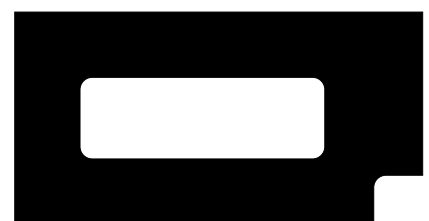
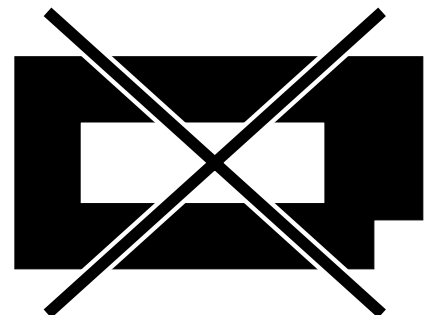

5 07

Material characteristics

- Due to the raw 'kraft paper' used to create Max HPL panels, the product has the same characteristics of both wood and paper products. These include swelling and shrinking both lengthwise and breadthwise.
- Therefore:
If the same factors are taken into account when using and processing Max HPL panels, as with hardwood, there will generally be no problem.

Max HPL panels require a tensionfree flat supporting surface with minimal movement. This is an essential prerequisite for the stable application of the Max HPL panel to the substructure.

- Electing the appropriate adhesive, the right amount, the right pressure and temperature during the bonding process, all significantly influence the surface stability of the glued composite material. For high-gloss surfaces, the following parameters must be considered:
 - a) smooth subsurface
 - b) low water content in glue
 - c) fast setting time

Due to their composition, Max HPL panels are subject to dimensional changes which differ from those of the sub-structure materials due to the influence of temperature and humidity. These different properties must be taken into account during processing.

Pre-conditioning

Because Max HPL panels and support panels/backing material may experience different dimensional changes, they should be conditioned together before processing – so that they can adjust their moisture content according to the environment. Materials that are processed damp or in wet conditions, can be prone to shrinking – leading to cracking and warping. Materials that are processed too dry, can later expand, potentially causing cracking or warping.

Effective **conditioning** can be achieved by ensuring a room temperature of around 15–25°C and relative humidity of 40–60%. Good air circulation around each individual panel is important. This process should take 1 week. Ideally, Max HPL and support panels should to be stacked in the same order in which they will be glued together. This process should take at least 3 days. The relative humidity during conditioning should be similar to the 'end' application environment.

Equalising Tension

Tension is always present between two mutually connected, different materials. Therefore, the substrate must be covered on both sides with materials which are subject to the same dimensional changes when exposed to heat and moisture. This is especially true if the finished composite panel is intended to be cantilevered and is not held directly by a rigid construction, e.g. doors. The larger the areas to be surfaced, the more attention must be paid to the balancing panel and the density, symmetrical structure and stiffness of the assembled panels.

- The best results are obtained by using the same Max HPL panel on the front and back. Both must also have the same running direction when cut out from the entire panel and glued. Not right-angled!
 - The Max HPL panels should be glued to the support simultaneously, from both sides, with the same running direction. Good results are also obtained by using so-called balancing panels of the same thickness. Care must be taken to ensure that both panels have been conditioned in the same way.
 - Under certain circumstances, it's feasible to use other backing materials, such as foils, wood veneers, lacquer coatings, impregnated papers, etc. However, it's always necessary to select a material whose physical properties are as close as possible to those of the Max HPL panel. Small tests should be carried out beforehand, but this is only useful for elements that are structurally fixed. It is difficult to predict the results from using such materials and therefore we cannot endorse them.
- In general, when gluing Max HPL panels, the following should be observed:
 - Same panel type (product) on both sides, as with veneering!
 - Same direction (cut) on both sides
 - Same panel thickness on both sides
 - Same conditioning procedure on both sides.

Support panels – e.g.:

- Chipboard
- MDF
- Hardboard
- Plywood

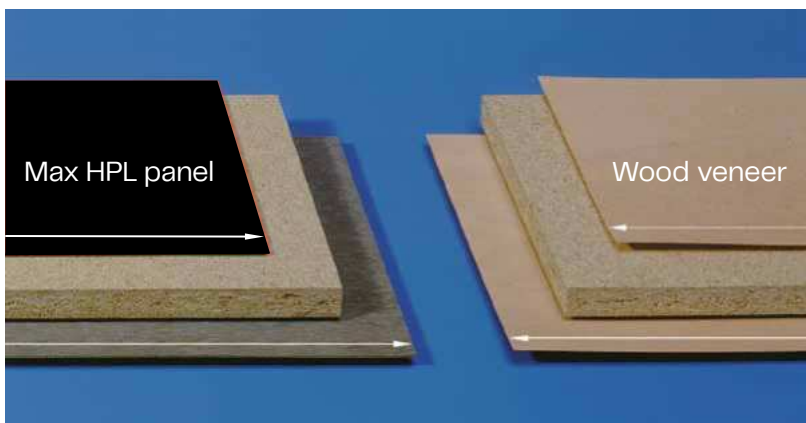

Panel type, running direction, panel thickness and conditioning grade

Gluing

Adhesives

- Dispersion adhesives
e.g. PVA glues = white glues
- Condensation resin adhesives
e.g. Urea, Resorcinol and Phenolic Resins
- Contact adhesives
e.g. Polychloroprene adhesives
- Reactive adhesives
e.g. Epoxy, Unsaturated Polyester, Polyurethane adhesives
- Hot-melt adhesives
For edge gluing, based on EVA, polyamide or polyurethane.

Bonding process

Both Max HPL panels and support materials must be thoroughly cleaned before bonding. They must be free from dust, grease, oil, moisture, or coarse particles, which can mark the surface once bonded. During bonding the ambient temperature should be 15 – 25°C with a relative humidity of 40 – 60%.

When choosing the best joint adhesive, attention must be paid to the **adhesion quality** of the support material and the stresses it may be subjected to. A joint adhesive with increased water resistance does not increase the water resistance of the carrier/support material!

Please refer to the guidelines and recommendations provided by your adhesive manufacturer. It's always best to carry out **trial tests** under local conditions. When working with adhesives, solvents and hardeners, please observe relevant health and safety guidelines.

Press/Setting Temperature

To avoid tension between composite elements, a setting temperature of 20°C, i.e. room temperature, should be used. Higher temperatures naturally reduce the setting time. However, the dimensional changes of the Max HPL panel in relation to the support material needs to be considered, and a temperature of 60°C should not be exceeded. Following temperature guidelines will avoid increased tension and warping of the panels. For Max HPL panels supplied with protective film, a setting temperature of 20°C is recommended. A higher setting temperature (60°C in this case) may adversely affect the removal of the protective film.

Bending radii

For cold forming, the smallest possible bending radius for 0.8 mm thick sheets is 180–200 mm, and the smallest possible radius for 1 mm thick sheets is 250 mm.

Postforming

The recommended bending temperature is 160°C to 170°C. The smallest possible bending radii for postforming HPL is 10 times the panel thickness parallel to the sanding direction and 20 times the panel thickness transverse to the sanding direction.



6 Cleaning recommendations for Max HPL panels and Aptico

If stains are unknown, please begin the process with the basic cleaning procedure, A to G (in order) until successful. To prevent streaking, a final clean must be carried out.

Please consider general precautions for Aptico as advised on page 19.

Basic cleaning

Please clean the surface using just pure hot water and a soft sponge – (Do not use the abrasive „green“ side of the sponge), use a soft cloth or a soft brush (e.g. nylon brush).

Cleaning procedure A

Same as the basic clean. In addition, use everyday household cleaning agents without abrasive ingredients such as washing liquid (Palmolive, Fairy etc), or glass cleaner (Mr. Muscle, Windolene, etc).

Cleaning procedure B

If the contamination cannot be removed using cleaning procedure A, use a soap–water solution (1:3). Depending on the degree of contamination, the soap–water may need to soak in for a period of time.

Cleaning procedure C

Same as basic cleaning, however, organic solvents (for example, acetone, alcohol, nitro thinner, turpentine) may also be used. Heavier soiling should be removed manually – but not in the case of high gloss or deep matt finishes. Caution: Avoid scratching – use a plastic or wooded spatula.

Cleaning procedure D

Same as basic cleaning but additionally you can use commercially available disinfectants. Steam cleaning is possible. Take care not to wet the supporting material (for example in the case of wood–based materials, wall cladding, insulation etc.).

Cleaning procedure E

Remove immediately! If necessary, perform cleaning procedure C again and don't forget the final cleaning process.

Cleaning procedure F

Rub the surface dry with a soft cloth or a soft sponge. If contaminants can't be removed, use a silicone remover (e.g. Molto).

Cleaning procedure G

For extremely adherent lime contaminants, acidic cleaning agents (e.g., 10% acetic acid or citric acid) can also be used.

Final cleaning

Rinse off detergents thoroughly with plenty of water to avoid streaks. Finally, rinse with pure hot water and dry by wiping the surface with an absorbent cloth or paper towel (kitchen roll). When cleaning with solvent: Observe accident prevention regulations! Open windows! No open flame!

General precautions

For best results when cleaning Aptico the following precautions must be taken:

- Despite its robust and resistant surface Aptico should never be treated with products which contain abrasives. Scouring sponges (green scouring fibres) or other such materials (abrasive paper or washing-up sponges) should not be used.
- Strong acidic or alkaline products should be avoided because they can alter the surface structure.
- If solvents are used, the cloth must always be clean, to prevent streaking the surface of Aptico.
- A final clean with hot water is always recommended.
- Polishes or waxy products should always be avoided as this can result in the loss of Aptico's excellent surface properties.

Type of stain	Cleaning procedure	Type of stain	Cleaning procedure	Type of stain	Cleaning procedure
Adhesives	C	Grease/Fat	A	Spray Paint	C
Bacteriological Contamination	D	Hybrid Adhesive	E	Stamping Ink	C
Blood	D	Insulating Foam	E	Synthetic Resin	E
Chalk	A	Lime Scale	G	Tar (Cigarettes)	C
Coffee	A	Lipstick	C	Tea	A
Dispersible (Pva)	C	Marker Pen	C	Two Component Adhesive	E
Dust	A	Mordant/Stain	C	Two Component Lacquer	E
Emulsion Paints	C	Paints (Graffiti)	C	Urea-Based Glue	E
Excrement	D	Pen	C	Urine	D
Fat, Oil	A, B, C	Pencil	A	Water Marks	G
Felt Tip Pen	C	Pu-Foam	E	Water Soluble Adhesives	A
Fingerprints	A	Rust	G	Water Soluble Paints	A
Floor Polish	B	Sealant (Silicone etc)	F	Wax Crayon	C
Fruit Juices	A	Shoe Cream	C	Wax Polish	C
Germes	D	Soap	A	Wax Residue	C

Please note that some adhesives can only be removed once hardened. (However there is danger of damaging the Max HPL surface!).

7 Max HPL panel with Aptico surface

Reveal Aptico

Max HPL panel with Aptico surface is an innovative product for interior design. Thanks to our next generation, patented surface technology, it delivers high-end aesthetics for high-end demands. The surface has unique features such as: low light reflection due to an extremely matt finish, a great texture, and anti-fingerprint properties. A further positive feature is the possibility of thermal repairs of any superficial microscratches.

The surface provides a high degree of resistance to scratches and abrasion, with optimum stain and chemical resistant properties thanks to its unique protective technology.

Application Areas for Aptico

Thanks to its special features, Aptico is suitable for both horizontal and vertical applications. It can be used in a wide range of interior designs, both for home and commercial sector applications: e.g. kitchens and bathrooms, work surfaces, furniture construction, doors and wall claddings. The Aptico surface is direction-oriented. Please note this when processing.

The physical qualities of the surface offer exceptional performance, making this material a great alternative to solid surfaces or glass, with the added advantage of simple processing.

In normal environments with approximately 15–25°C and 40–60% relative humidity, a standard HPL with the same decor can be used as a backing panel.

Areas with more demanding conditions such as a very high or very low humidity, e.g. wet rooms or heavily air-conditioned rooms, require symmetrical assembly. Aptico must be selected for both sides.



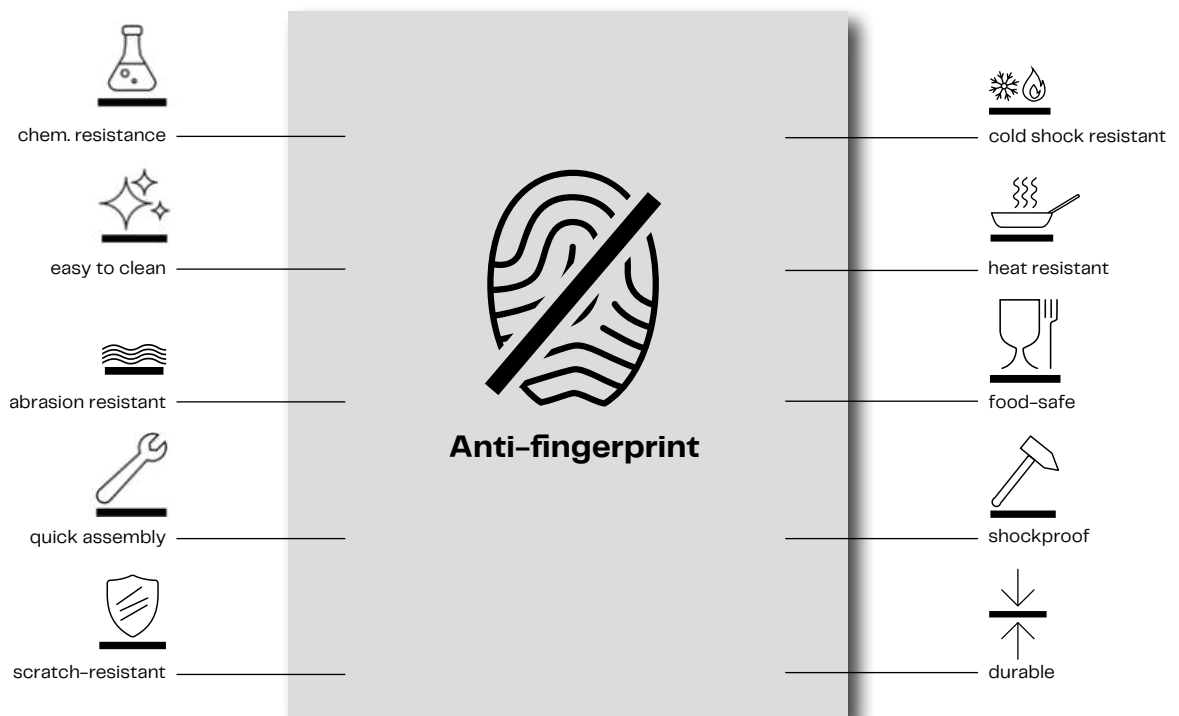

Advantages of Aptico

- Anti-fingerprint
- Gentle light reflection thanks to an extremely matt surface
- Matt finish with a warm texture
- Thermal repair of superficial micro-scratches possible
- Resistant to scratches and abrasions
- Resistant to solvents and household cleaners
- Easy to maintain and very easy to process

Thermal repair of microscratches

Iron repair

One of the most innovative features of Aptico is the possibility of thermal repair to superficial microscratches (Fig. 15). The following repair instructions are suitable for HPL and Compact panels with the Aptico surface.

- Moisten/wet some kitchen paper using pure water from a spray bottle and position it on top of the damaged area. (Fig. 6 02).
- Heat an iron to about 180°C, and then move this across the wet kitchen paper in a circular motion for max.10 seconds (Fig. 6 03).
- Dry the surface with a clean, dry cloth (Fig. 6 04 and Fig. 6 05).

Note: It is recommended to repair micro-scratches within 48 hours.



7 03

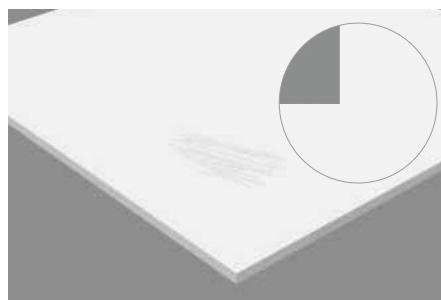

7 01



7 04

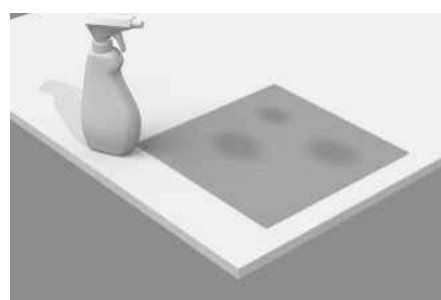

7 02

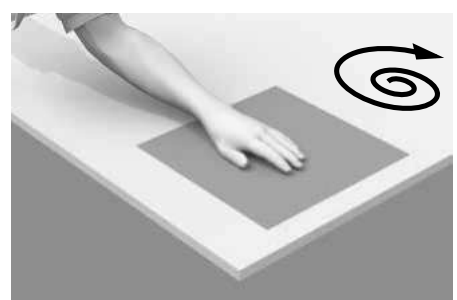

7 05

Liability Disclaimer

The information provided in this document is for general reference purposes only. Not all systems named and illustrated are suitable for all applications/areas. All customers and third parties are obliged to inform themselves about Fundermax products as well as their suitability for specific purposes. We strongly recommend that anyone using our products seeks independent expert advice regarding compliance, local planning and application requirements, applicable laws, regulations, guidelines and test standards. Fundermax accepts no liability in connection with the use of this document.

Responsibility for correct and appropriate planning and execution lies solely with the planner and the processor. The general terms and conditions of the sale of Fundermax GmbH products can be found on our website www.fundermax.acom. These apply to all our oral, as well as written comments, offers, quotations, sales, deliveries and/or contracts and related activities.

Copyright

All text, photographs, graphics, audio and video files are protected by copyright laws, as well as intellectual property laws, and may not be duplicated, altered or used on other websites for commercial or financial gains.

Fundermax Deutschland GmbH

Mundenheimer Weg 2
67117 Limburgerhof
infogermany@fundermax.biz
www.fundermax.de

Fundermax France S.a.r.l.

3 Cours Albert Thomas
F-69003 Lyon
Telefon: +33 (0)4 78682831
infofrance@fundermax.biz
www.fundermax.fr

Fundermax India Pvt. Ltd.

Sy. No. 7, Honnenahalli, Doddballapur Road,
IND-Yelahanka Hobli, Bangalore - 560064
officeindia@fundermax.biz
www.fundermax.in

Fundermax Italia s.r.l.

Viale Venezia 22
I-33052 Cervignano del Friuli
infoitaly@fundermax.biz
www.fundermax.it

Fundermax North America, Inc.

9401-P Southern Pine Blvd.
US-Charlotte, NC 28273
Telefon: +1 (0)980 2990035
office.america@fundermax.biz
www.fundermax.us

Fundermax Polska Sp.z.o.o.

ul. Rybitwy 12
PL-30 722 Kraków
Telefon: +48 (0)12 6534528
infopoland@fundermax.biz

Fundermax Swiss AG

Industriestrasse 38
CH-5314 Kleindöttingen
Telefon: +41 (0)56 2688311
infoswiss@fundermax.biz
www.fundermax.ch

Fundermax GmbH

Klagenfurter Straße 87-89, A-9300 St. Veit/Glan
T: +43 (0)5 9494-0, F: +43 (0)5 9494-4200
office@fundermax.at
www.fundermax.com

